



Culligan®

**Culligan®
Aqua-Clear®
Advanced
Drinking
Water
Systems
Owners
Guide**





THANK YOU

AND WELCOME TO YOUR NEW WORLD OF BETTER LIVING WITH CULLIGAN WATER.

Notice: Do not use with water that is microbiologically unsafe or of unknown quality without adequate disinfection before or after the system. Systems certified for cyst reduction may be used on disinfected water that may contain filterable cysts.

For installations in Massachusetts: Massachusetts Plumbing Code 248 CMR shall be adhered to. Consult your licensed plumber for installation of this system. The use of saddle valves is not permitted in Massachusetts.

Check with your public works department for applicable local plumbing and sanitation codes. Follow your local codes if they differ from the standards used in this manual.

Operational, maintenance and replacement requirements are essential for this product to perform properly. Talk to your Culligan dealer about a service and maintenance program to ensure your filters are replaced in a timely manner and annual water tests are also recommended (especially on well water) to ensure the system is functioning properly.

**Culligan International Company
9399 West Higgins Road
Rosemont, IL 60018
1-800-Culligan
www.culligan.com**

Products manufactured and marketed by Culligan International Company (Culligan) and its affiliates are protected by patents issued or pending in the United States and other countries. Culligan reserves the right to change the specifications referred to in this literature at any time, without prior notice. Culligan, Aqua Clear, and Culligan Man are trademarks of Culligan International Company or its affiliates.



About Your System	4
Installation	7
How to Maintain Your System	11
Parts List	13
Performance Data Sheet	14
CDPH Certificates	45
Arsenic Fact Sheet	54
Troubleshooting Guide.	56
Service Log	58
Warranty	59

Table of Contents



About Your System

Thank you for choosing a Culligan Aqua-Clear advanced drinking water system. Your new system is designed to bring you years of deliciously crystal-clear Culligan water. The best part is it comes right from the tap. No more lugging around bottles or waiting for pitchers to slowly fill up. With your continuous supply of great tasting water, not only can you get your 8 glasses a day but you can easily use it for cooking, coffee, juice, baby formula, ice cubes, anything you use water with.

The important thing to remember is to change out your filters on a regular basis. The quality of your water is only as good as the quality of your filters. Each filter is designed to last for 1,000 gallons (roughly 12 months). Membranes will last longer if used with pre-filtration. A flow monitor is available with your system to let you know when you have consumed 1,000 gallons of water through your system. If you did not purchase one with your system, you may consider asking your Culligan man about having one installed. Faucets with reminder lights are also available.

System Specifications:

Dimensions	Filter Assembly	13.8" wide x 4.2" deep x 15.5" high
	Standard Storage Tank	9" diameter x 14" high
	Medium Storage Tank	11" diameter x 14" high
	Large Storage Tank	15.5: diameter x 24" high
Storage Tank Capacity	Standard	2 gallons
	Medium	3 gallons
	Large	9 gallons
Reverse Osmosis Efficiency Rating	Standard	16.86%
	Medium	16.86%
	Large	16.86%
Reverse Osmosis Recovery Rating	Standard	33.49%
	Medium	33.49%
	Large	33.49%

Filtration Options:

Sequence of Filtration	Type of Filtration	Specification
Pre-Filtration	Sediment	1
		2
3		
Membrane	Carbon	Block
		Granulated Active Carbon
	Nano Filtration*	30 gpd
		50 gpd
		30 gpd

* Cartridges not for sale in California or Iowa.

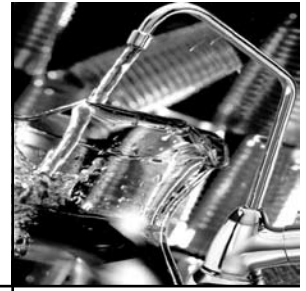

About Your System (con't)

Sequence of Filtration	Type of Filtration	Specification
Advanced Filtration	Total Defense	Speciality Carbon Block
	Arsenic	Specialty Media ¹
	Perchlorate*	Specialty Media ¹
Post-Filtration	Carbon	Granulated Activated Carbon Block

* Cartridges not for sale in California

¹ Specialty media cartridges must be installed after the RO membrane and system must have a Performance Indicator Device (PID) installed to track gallon usage.

Purpose of each level of filtration:

Pre-Filtration:

Pre-filtration for this system is used to reducing large contaminants from the water before they reach either the reverse osmosis or nano filtration membrane. The use of pre-filtration cartridges helps extent the membrane's life. There are two types of pre-filtration available with this system: sediment filtration and carbon filtration.

Sediment Filtration: Sediment is defined as sand, dirt, silt, fine sand and or coarse sand that can be found in many water supplies.

Carbon Filtration: Carbon is used to reduce chlorine taste and odor. Most people often describe this taste as being slightly chemical or they equate their drinking water to that of the local pool. Municipalities use chlorine to disinfect the water on the way to your home. This is a necessary step to delivering safe water to your home but depending on the level of chlorine by the time it reaches your home the taste of your water may be unpalatable.

Membrane Technologies:

The Aqua-Cleer system can utilize two different membrane technologies; reverse osmosis and nano filtration. Each one of these technologies use a tightly woven membrane that acts as a barrier to contaminants. Water is pushed up against this membrane at pressure. Depending on the weave of the membrane only a certain percentage of contaminants can pass through. Reverse Osmosis can reduce up to 99% of contaminants. The reason you may choose nano filtration versus reverse osmosis is often a question of taste. Some of the things that give water its taste are minerals such as calcium and magnesium. A nano filtration membrane will leave more of those minerals in the water.

Advanced Filtration:

The advanced filtration cartridges are specifically designed to reduce contaminants that reverse osmosis membranes are not efficient in removing.

Total Defense:

The Total Defense cartridge should be added to your system to deal with lead, mercury, chloramines, aesthetic chlorine taste and odor, cysts, Volatile Organic Compounds (VOC) and MTBE.



About Your System (con't)

- Chloramines have a stronger taste and are more difficult to remove than chlorine.
- Mercury is a toxin that can cause kidney damage.
- Lead is a toxin that can cause kidney problems or high blood pressure in adults and developmental problems in children.
- Cysts are a common cause of health issues. They can be found in some municipal water sources but more often found in wells under the influence of surface water.
- VOC is a name given to a wide range of organic contaminants, some are known to be carcinogenic.
- MTBE was used in gasoline to reduce emissions and is considered harmful.

Perchlorate*:

Perchlorate is a by-product of munitions manufacturing (common in solid rocket fuel, road flares, etc) that can be found in some water sources.

Arsenic:

Arsenic (As) is found naturally in some well water. Arsenic in water has no color, taste or odor. It must be measured by a lab test. Public water utilities must have their water tested for arsenic. You can get the result from your water utility. If you have your own well, you can have the water tested by an accredited lab. The local health department or the state environmental health agency can provide a list of certified labs. Culligan International is one such lab. For more information please contact your local Culligan dealer. For additional information about the arsenic in water can be found through the EPA's website at www.epa.gov/safewater/arsenic.html.

There are two forms of arsenic: pentavalent arsenic (As (V)) and trivalent arsenic (As (III)). Special sampling procedures are needed to a lab to determine what type and how much of each type of arsenic is in the water. In well water, arsenic may be pentavalent, trivalent, or a combination of both. Reverse osmosis membranes are effective at reducing pentavalent arsenic but not trivalent arsenic. The Arsenic specific cartridge was specifically designed to reduce trivalent arsenic.

* Cartridges not for sale in California.



Installation

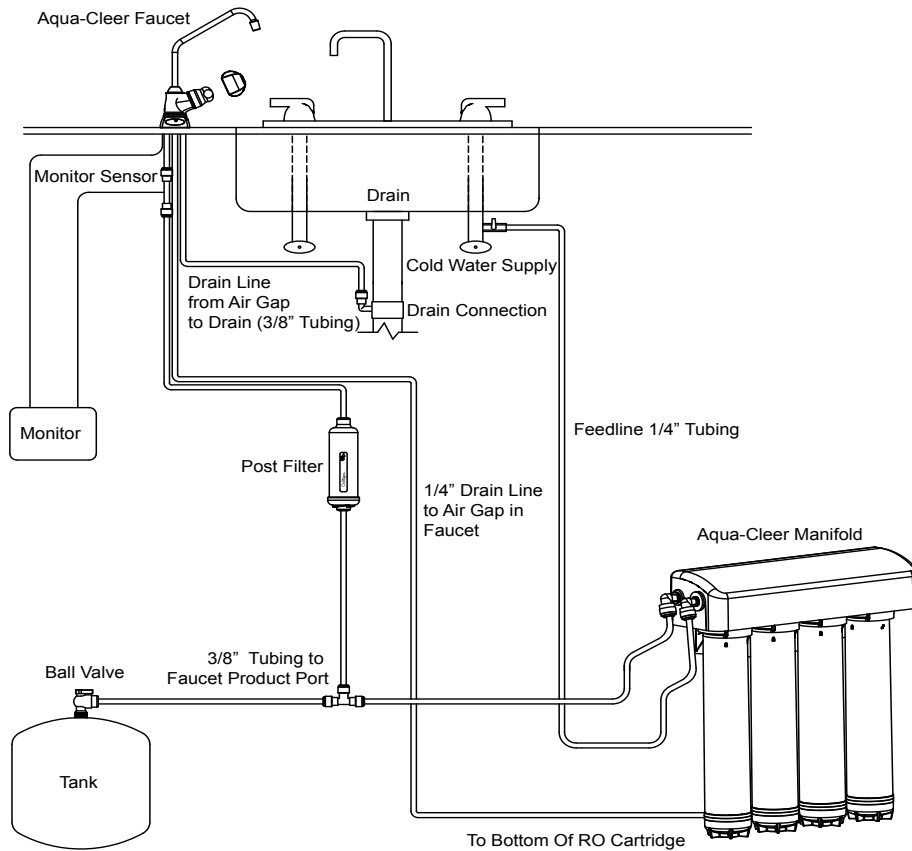

Note: Install the drain line so that it runs downward with no loops or low spots. Otherwise the unit will overflow at the air gap siphon break built into the faucet, or make irritating gurgling sounds. The 1/4" concentrate line that leads to the faucet should be installed in a straight vertical path to avoid making a gurgling noise. **For installations in Massachusetts: Massachusetts Plumbing Code 248 CMR shall be adhered to. Consult your licensed plumber for installation of this system. The use of saddle valves is not permitted in Massachusetts.**

This owner's guide provides visual assembly reference only. Since specialized skills are required in the assembly of the drinking water system, we recommend that you contact your local independently operated Culligan dealer to complete this installation.

Select Component Installation Locations

Dispenser Faucet

The Culligan® faucet is designed to be mounted on the rear lip of the sink. It may be installed in an existing sprayer attachment hole or in a hole drilled at the time of installation. It may also be mounted to an adjacent counter top. It should be positioned so that water is dispensed over the sink. A minimum 1-1/4" diameter hole is required. When installing the Aqua-Clear® water quality monitor, refer to the installation instructions packaged with the monitor. Make certain the TDS level and/or gallons setting correspond to the desired water supply.



Installation (con't)

Important considerations:

- Access to the bottom (under sink) of the faucet is required for attachment of product water line.
- The faucet can be installed for left- or right-handed operation.
- There should be no under sink obstructions which would prevent smooth tubing runs to the drain connection, carbon post-filter, or RO module assembly.

Filter System Assembly

The filter system assembly is designed to be mounted on any rigid vertical surface such as a cabinet sidewall, sheetrock or exposed stud. It should be positioned such that there is access to an inlet water source and drain. The installation should also allow convenient access for servicing.

Inlet Water Supply Connection

Once a location is chosen for installation of the filter system assembly, select a nearby cold water line to provide the water source for the system. For under sink installations, the cold water faucet line can usually be tapped.

The Reservoir Tank

Position the reservoir tank near the faucet for optimum customer convenience. The standard and medium reservoir tank will weigh about 28 pounds (13 kg) when full of water, so it must be positioned on a stand or held securely by the optional mounting bracket. The reservoir operates best in the vertical position, but it will operate on its side. However, air will not escape readily and foaming may occur at the faucet nozzle. This should be explained to the customer prior to installation.

Drain Connection

The most convenient entry to the drain is directly above the P-trap of the kitchen sink. However, the concentrate water from the system can be connected to adjacent sinks or a floor drain. Extra care should be taken when entering drains near dishwashers or food waste disposals as back flow may occur through the air gap and cause flooding. See plumbing diagram on page 7 for proper air gap installation to waste connection.

Installation of Filter System Assembly

The mounting bracket contains three mounting slots. The holes are sized to accept #10 round head wood screws (not supplied). Some types of surfaces such as particle board or drywall may require the use of plastic screw anchors or toggle bolts to provide adequate support for the unit.

Install Filter Cartridges

1. Lightly lubricate the cartridge O-ring with silicone lube and insert the sediment filter cartridge into the manifold.
2. Twist the cartridge to lock it into the manifold. See Figure 2.

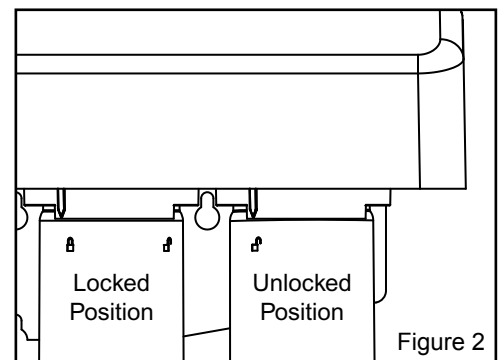



Installation (con't)

3. Repeat steps 1-3 and install the flushed activated carbon filter cartridge into housing and the RO membrane element. Be sure the drain adapter is in place.

Note:

- 1) The RO cartridge must be inserted into the 2nd, 3rd, or 4th position on the RO manifold.
- 2) If only three cartridges are to be inserted into the manifold, the bypass plug cartridge must be inserted in the 4th position. See Figure 3.

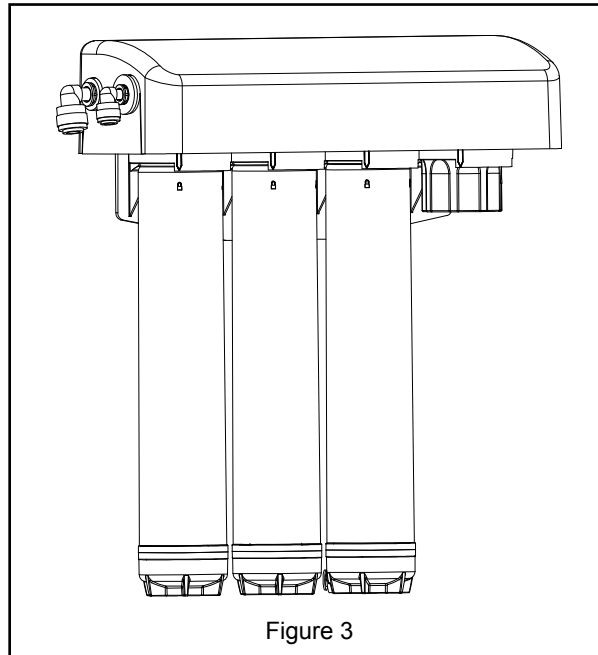

Factors Which Affect Performance

Performance of the reverse osmosis membrane is affected by several factors which must be considered when judging the condition of the system. The main factors which affect system performance are pressure, temperature, total dissolved solids level, recovery and pH.

Pressure

Water pressure affects both the quantity and quality of the water produced by the RO membrane. Generally, the more water pressure, the better the performance of the system. Be careful not to exceed 120 psi, the maximum operating pressure of the Aqua-Clear system.

Temperature

The reverse osmosis process slows with decreasing temperature. To compensate, a temperature correction factor is used to adjust the actual performance of the RO membrane filter to the standard temperature of 77°F (25°C). This allows the performance of the unit to be accurately gauged against Culligan's published standards. Temperature does not affect the concentrate flow rate.

Total Dissolved Solids

The minimum driving force which is necessary to stop or reverse the natural osmosis process is termed osmotic pressure. As the total dissolved solids level of the feed water increases, the amount of osmotic pressure increases and acts as back pressure against the reverse osmosis process. Osmotic pressure becomes significant at TDS levels above 500 mg/L (ppm).

Hardness

Hardness is the most common membrane foulant. If ignored, this relatively harmless



Installation (con't)

component of feed water will plug a membrane over time. Use of a softener will reduce the fouling effect on a membrane. One way to detect too much hardness in the feed water is the weight of a membrane installed for a period of time. A fouled membrane (dried) will weigh significantly more than a new membrane. The increase in weight is a result of precipitated hardness inside the membrane.

Iron

Iron is another common membrane foulant. There are a variety of types of iron, some of which cannot be removed by an iron filter. Clear water iron can be removed more effectively by a softener. Particulate iron can be removed more effectively by a 1 micron filter. Organic-bound iron can be removed only by activated carbon or macroporous anion resin. If there is enough iron to exceed the EPA secondary drinking water standard and softening the water is not an option and the iron is soluble, then an iron filter is appropriate. If none of these are an option then regular replacement of membranes will have to be accepted.

Product Water Recovery

Product water recovery plays an important role in determining membrane and system performance. Recovery refers to the amount of water produced in relation to the amount of water sent to drain. The standard calculation is:

$$\% \text{ Recovery} = \text{Product Water} \div (\text{Product Water} + \text{Waste Water}) \times 100$$

The Aqua-Clear uses a flow control assembly to restrict the flow of waste water to the drain. This restriction helps maintain pressure against the membrane. The sizing of the flow control assembly determines the recovery rating of the system. The Aqua-Clear is manufactured with a recovery rating designed to be around 30% -40%. Depending on temperature, pressure and tolerances the actual recovery value may be slightly different for each system.



How to Maintain Your System

To keep the Aqua-Cleer® system operating properly, it is necessary to change the filters and sanitize the system periodically. Typically, this should be done on an annual basis. Service frequency may vary depending on local water conditions. High sediment, chlorine, turbidity, or hardness levels may require more frequent service. Use the following as a guide.

As needed:

Clean the faucet with a soft cloth, avoid abrasive cleaners

It is recommended that you do the following annually:

1. Sanitize the System

2. Replace:

- Sediment Filter
- Activated Carbon Filter
- Polishing Filter
- Any Advanced Filtration Cartridge

3. Check:

- RO Membrane
- Flow control assembly
- TDS Reduction Performance
- Flow Rates (including air gap)
- Drain tubing for back-up

NOTE:

The activated carbon, reverse osmosis, and polishing filter cartridges must be conditioned as follows prior to installation into the Aqua-Cleer system. Your Culligan man will do these important procedures at the time of purchase.

- Activated Carbon Cartridge - 10 minute flush to remove carbon dust
- RO Membrane - Minimum 24 hour flush to remove preservative solution
- Polishing Filter - 10 minute flush to remove carbon dust

Perform the following steps in the order shown to sanitize your system

It is recommended to have your local Culligan dealer perform the sanitization process. Your local Culligan man has been specifically trained to test the water quality and efficiency of the system in order to determine when the RO membrane should be replaced and ensure the system is working properly.



How to Maintain Your System (con't)

Preliminary Steps:

1. Check for any leaks that may exist from tubing connections or the faucet.
2. Check for flow to the drain. If flowing, close tank shut-off so you can check auto shut-off operation
3. Test and record product TDS from faucet. Also observe if faucet stem is stiff to move.
4. Test and record feed TDS, and then calculate rejection percentage.
5. If rejection is acceptable - Shut off storage tank, remove tank supply tubing to collect and record product flow, and water temperature.
6. Record feed pressure if needed by attaching a pressure gauge to feed line. Use the recorded feed pressure and water temperature to check product flow rate against the supplied chart. Membrane okay? Low production could be the result of partially plugged prefilters. If so retest after filters are changed.
7. With feed line off begin draining tank.

The Aqua-Clear RO manifold assembly may be sanitized with 5-1/4% liquid chlorine unscented bleach.

1. Shut off water supply then remove all filters. Put bypass plugs in ports 2, 3 and 4.
2. Pour two tablespoons liquid chlorine bleach into the sanitizer cartridge and place in port 1.
3. Turn on the water supply valve and the RO faucet to allow the system to fill with water. Allow the water to flow through until the entire system for about 10 minutes or until the sanitizing solution is through.
4. Install new filters, including the post carbon filter, and membrane if needed, or reuse existing membrane. Some filters require flushing before use to remove dust and fines. If an in-plant flush was not performed, use the single head assembly to perform this using the feed line and drain lines available. Don't flush using the RO manifold.
5. Replace the battery in the quality monitor if applicable.
6. Discard the first glass of water from the faucet.
7. Thoroughly check for leaks.

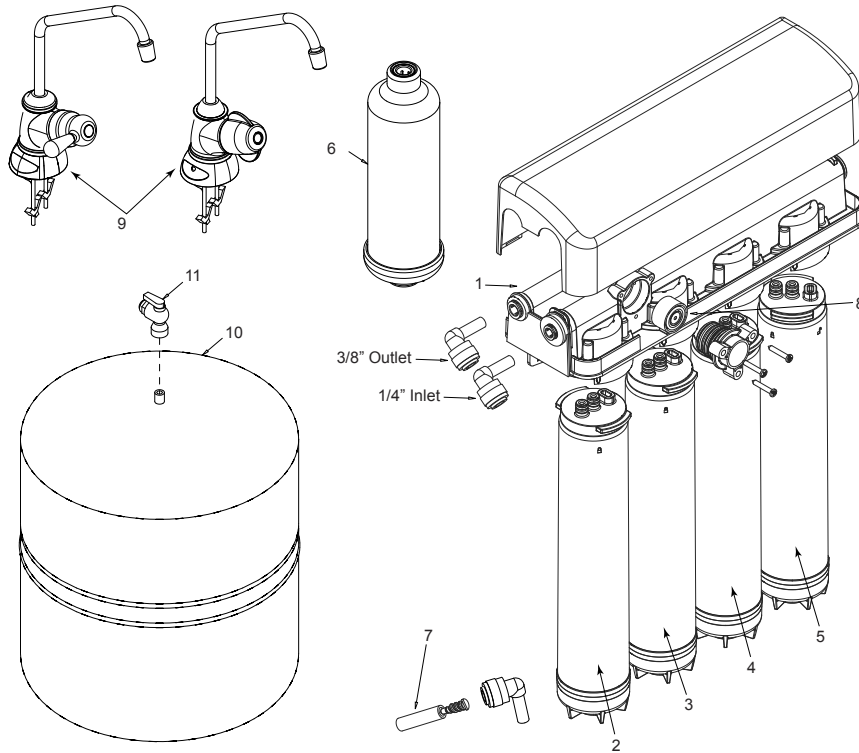
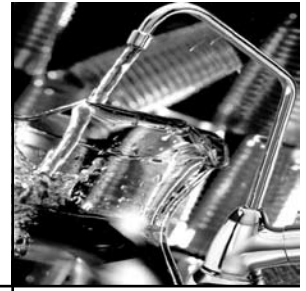

Parts List

Item	Description
1	Manifold Assembly
2	SED1 Filter
	SED2 Filter
	SED3 Filter
3	Carbon Block Filter
	Granular Activated Carbon Filter
4	30 GPD Reverse Osmosis Membrane
	50 GPD Reverse Osmosis Membrane
	Nanofiltration Reverse Osmosis Membrane**†
5	Arsenic Filter
	Perchlorate Filter**
	Carbon Block Filter (MTBE, VOC)
6	Post Carbon Filter
7	Flow Control
8	Automatic Shut-off Valve
9	Faucet
10	2 Gallon Storage Tank
	3 Gallon Storage Tank
	9 Gallon Storage Tank
11	Ball Valve

*Monitor (Not Shown)
 **Cartridges not for sale in California
 † Cartridge not for sale in California or Iowa



Performance Data Sheet

Important Notice: Read this Performance Data Sheet and compare the capabilities of this system with your actual water treatment needs. It is recommended that, before installing a water treatment system, you have your water supply tested to determine your actual water treatment needs.

Culligan knows the more informed you are about your water treatment systems, the more confident you will be about its performance. It's because of this and more than seventy years of commitment to customer satisfaction that Culligan is providing this Performance Data Sheet to its customers.

Company: **Culligan International Company**
9399 West Higgins Road, Suite 1100
Rosemont, IL 60018 USA
(847) 430-2800

Product: Culligan Aqua-Clear Advanced Drinking Water Systems

Use Guidelines:

- Working Pressure: 40 – 120 psig (280-827 kPa)
- Do not allow exposure to temperature below 33°F (1°C)
- Maximum operating temperature: 100°F (38°C)
- These systems must be installed according to local plumbing codes on the cold water line.
- This system requires regular replacement of all filters to maintain proper operation. Depending on usage and influent water quality, the carbon and particulate filters should be changed at least annually and the reverse osmosis membrane should be replaced every 3-5 years. Varying chlorine, sediment or TDS levels may affect replacement frequency.



CAUTION! Do not use with water that is microbiologically unsafe or of unknown quality without adequate disinfection before or after the system. Systems certified for cyst reduction may be used on disinfected water that may contain filterable cysts.



Performance Data Sheet (con't)

Total Defense (TD)

The Total Defense has been tested according to NSF/ANSI 42 and 53 for the reduction of the substances listed below. The concentration of the indicated substances in the water entering the system was reduced to a concentration less than or equal to the permissible limit for water leaving the system, as specified in NSF/ANSI 42 and 53.

Substance	Influent Challenge Concentration	Maximum Permissible Product water Concentration	Reduction Requirements	Minimum Reduction	Average Reduction
Standard 42					
Aesthetic Chlorine	2.0 mg/L + 10%		>50%	97.6%	98.0%
Chloramines	3.0 mg/L + 10%	0.5 mg/L		97.6%	98.0%
Particulate (0.5 - < um) Class I	At least 10,000 particles/mL		>85%	99.9%	99.9%
Standard 53					
MTBE	0.015 + 20%	0.005 mg/L		74.6%	83.3%
Cyst †	Minimum 50,000/L		99.95%	99.99%	99.99%
Turbidity	11 mg/L + 1 NTU	0.5 NTU		96.6%	98.0%
Lead (pH 6.5)	0.15 mg/L + 10%	0.010 mg/L		99.3%	99.3%
Lead (pH 8.5)	0.15 mg/L + 10%	0.010 mg/L		99.3%	99.3%
Mercury (pH 6.5)	0.006 mg/L + 10%	0.002 mg/L		96.6%	96.6%
Mercury (pH 8.5)	0.006 mg/L + 10%	0.002 mg/L		72.4%	95.4%
Chloroform (VOC surrogate chemical)	0.300 mg/L + 10%	0.015 mg/L		95.2%	91.0%

Flow Rate = 0.5 gpm (1.89 Lpm)
Capacity = 1,000 gallons (3786 L)

† Based on the use of microspheres or *Cryptosporidium parvum* oocysts

Testing was performed under standard laboratory conditions, actual performance may vary.



**Performance
Data Sheet
(con't)**

Organic Chemicals Included in Surrogate Testing:

Applies to Total Defense (TD) only.

Substance	Influent Challenge Concentration mg/L	Maximum permissible product water concentration mg/L
Alachor	0.050	0.001
Atrazine	0.100	0.003
Benzene	0.081	0.001
Carbofuran	0.190	0.001
Carbon Tetrachloride	0.078	0.002
Chlorbenzene	0.077	0.001
Chlorpicrin	0.015	0.000
2,4-d	0.110	0.002
Dibromochloropropane (Dbcp)	0.052	0.000
O-Dichlorobenzene	0.080	0.001
P-Dichlorobenzene	0.040	0.001
1,2-Dichloroethane	0.088	0.005
1,1-Dichloroethylene	0.083	0.001
Cis-1,2-Dichloroethylene	0.170	0.001
Trans-1,2-Dichloroethylene	0.086	0.001
1,2-Dichloropropane	0.080	0.001
Cis-1,3-Dichloropropylene	0.079	0.001
Dinoseb	0.170	0.000
Endrin	0.053	0.001
Ethylbenzene	0.088	0.001
Ethylene Dibromide (Edb)	0.044	0.000
Haloacetonitriles (Han):		
Bromochloroacetonitrile	0.022	0.001
Dibromoacetonitrile	0.024	0.001
Dichloroacetonitrile	0.001	0.000
Trichloroacetonitrile	0.015	0.000
Haloketones (Hk):		
1,1-Dichloro-2-propane	0.007	0.000
1,1,1-Trichloro-2-propane	0.008	0.000
Heptachlor	0.250	0.000
Heptachlor Epoxide	0.011	0.000
Hexachlorobutadiene	0.044	0.001
Hexachlorocyclopentadiene	0.060	0.000
Lindane	0.055	0.000
Methoxychlor	0.050	0.000
Pentachloophenol	0.096	0.001
Simazine	0.120	0.004



Organic Chemicals Included in Surrogate Testing (Continued):

Applies to Total Defense (TD) only.

**Performance
Data Sheet
(con't)**

Substance	Influent Challenge Concentration mg/L	Maximum permissible product water concentration mg/L
Styrene	0.150	0.001
1,1,2,2-Tetrachloroethane	0.081	0.001
Tetrachloroethylene	0.081	0.001
Toluene	0.078	0.001
2,4,5-tp (Silvex)	0.270	0.002
Tribromoacetic Acid	0.042	0.001
1,2,4-Trichlorobenzene	0.160	0.001
1,1,1-Trichloroethane	0.084	0.005
1,1,2-Trichloroethane	0.150	0.001
Trichloroethylene	0.180	0.001
Trihalomethanes (Includes):		
Chloroform (Surrogate Chemical)		
Bromoform	0.300	0.015
Bromodichloromethane		
Chlorodibromomethane		
Xylenes (Total)	0.070	0.001



Performance Data Sheet (con't)

RO30

This system has been tested according to NSF/ANSI 58 for the reduction of the substances listed below. The concentration of the indicated substances in water entering the system was reduced to a concentration less than or equal to the permissible limit for water leaving the system, as specified in NSF/ANSI 58.

This system is acceptable for treatment of influent concentrations of no more than 27 mg/L nitrate and 3 mg/L nitrite in combination measured as N and is certified for nitrate/nitrite reduction only for water supplies with a pressure of 280 kPa (40 psig) or greater.

Substance Reduction¹

Substance	Influent Challenge Concentration mg/L	Maximum Permissible Product water Concentration mg/L	Reduction Requirements	Minimum Reduction	Average Reduction
Arsenic (Pentavalent) ²	0.050 +/- 10%	0.01			97.4%
Barium	10.0 +/- 10%	2			93.8%
Cadmium	0.03 +/- 10%	0.005			98.7%
Hexavalent Chromium	0.30 +/- 10%	0.05			91.2%
Trivalent Chromium	0.30 +/- 10%	0.05			94.8%
Copper	3.00 +/- 10%	1.3			98.9%
Fluoride	8.0 +/- 10%	1.5			95.6%
Lead	0.15 +/- 10%	0.010			98.7%
Nitrate/Nitrite (both as N)	30 +/- 10%			82.8%	86.4%
Nitrate ⁵	27.0 +/- 10%	10.0		82.7%	86.5%
Nitrite	3.0 +/- 10%	1.0		80.9%	84.7%
Radium 226/228 ³	25pCi/L +/- 10%	5pCi/L			80.0%
Selenium	0.10 +/- 10%	0.05			96.0%
Cyst ⁴	>50,000/mL		99.95%	99.99%	99.99%
Turbidity	11 +/- 1 NTU	0.5 NTU			99.00%

¹ While testing was performed under standard laboratory conditions, actual performance may vary depending on water pressure, temperatures and other substances, which may be found in your water.

² This system has been tested for the treatment of water containing pentavalent arsenic (also known as As(V), As(+5) or arsenate) at concentrations of 0.050 mg/L or less. This system reduces pentavalent arsenic, but may not remove other forms of arsenic. This system is to be used on water supplies containing a detectable free chlorine residual at the system inlet or on water supplies that have been demonstrated to contain only pentavalent arsenic. Treatment with chloramines (combined chlorine) is not sufficient to ensure complete conversion of trivalent arsenic to pentavalent arsenic. Please see the Arsenic Facts Sheet for further information.

³ Based upon testing methods using Barium as a surrogate. All concentrations in pCi/L pico curie/L.

⁴ Includes Giardia lamblia, Entamoeba histolyca and Cryptosporidium.

⁵ Units are not certified on water supplies with a pressure less than 40 psi (280 kPa). A booster pump is strongly recommended.

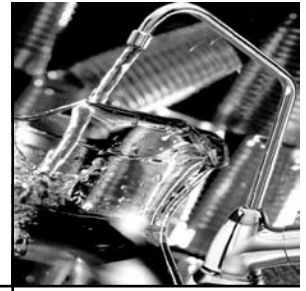

Performance Data Sheet (con't)

RO30 with TD

These systems have been tested and certified by NSF International according to NSF/ANSI 42, 53, and 58 for the reduction of the substances listed below. The concentration of the indicated substances in water entering the system was reduced to a concentration less than or equal to the permissible limit for water leaving the system, as specified in NSF/ANSI 42, 53, and 58.

This system is acceptable for treatment of influent concentrations of no more than 27 mg/L nitrate and 3 mg/L nitrite in combination measured as N and is certified for nitrate/nitrite reduction only for water supplies with a pressure of 280 kPa (40 psig) or greater.

Substance Reduction¹

Substance	Influent Challenge Concentration mg/L	Maximum Permissible Product water Concentration mg/L	Reduction Requirements	Minimum Reduction	Average Reduction
Arsenic (pentavalent) ²	0.050 +/- 10%	0.01			97.4%
Barium	10.0 +/- 10%	2			93.8%
Cadmium	0.03 +/- 10%	0.005			98.7%
Hexavalent Chromium	0.30 +/- 10%	0.05			91.2%
Trivalent Chromium	0.30 +/- 10%	0.05			94.8%
Copper	3.00 +/- 10%	1.3			98.9%
Fluoride	8.0 +/- 10%	1.5			95.6%
Lead	0.15 +/- 10%	0.010			98.7%
Nitrate/Nitrite (both as N)	30 +/- 10%			83.1%	86.8%
Nitrate ⁵	27.0 +/- 10%	10.0		83.4%	87.0%
Nitrite	3.0 +/- 10%	1.0		79.5%	84.8%
Radium 226/2283	25pCi/L +/- 10%	5pCi/L			80.0%
Selenium	0.10 +/- 10%	0.05			96.0%
Cyst ⁴	>50,000/mL		99.95%	99.99%	99.99%
Turbidity	11 +/- 1 NTU	0.5 NTU			99.00%

¹ While testing was performed under standard laboratory conditions, actual performance may vary depending on water pressure, temperatures and other substances, which may be found in your water.

² This system has been tested for the treatment of water containing pentavalent arsenic (also known as As(V), As(+5) or arsenate) at concentrations of 0.050 mg/L or less. This system reduces pentavalent arsenic, but may not remove other forms of arsenic. This system is to be used on water supplies containing a detectable free chlorine residual at the system inlet or on water supplies that have been demonstrated to contain only pentavalent arsenic. Treatment with chloramines (combined chlorine) is not sufficient to ensure complete conversion of trivalent arsenic to pentavalent arsenic. Please see the Arsenic Facts Sheet for further information.

³ Based upon testing methods using Barium as a surrogate. All concentrations in pCi/L pico curie/L.

⁴ Includes Giardia lamblia, Entamoeba histolyca and Cryptosporidium.

⁵ Units are not certified on water supplies with a pressure less than 40 psi (280 kPa). A booster pump is strongly recommended.



Performance Data Sheet (con't)

Total Defense (TD)

The Total Defense has been tested according to NSF/ANSI 42 and 53 for the reduction of the substances listed below. The concentration of the indicated substances in the water entering the system was reduced to a concentration less than or equal to the permissible limit for water leaving the system, as specified in NSF/ANSI 42 and 53.

Substance Reduction¹

Substance	Influent Challenge Concentration mg/L	Maximum Permissible Product water Concentration mg/L	Reduction Requirements	Minimum Reduction	Average Reduction
Standard 42					
Aesthetic Chlorine	2.0 mg/L + 10%		>50%	97.6%	98.0%
Chloramines	3.0 mg/L + 10%	0.5 mg/L		97.6%	98.0%
Particulate (0.5 - < um) Class I	at least 10,000 particles/mL		>85%	99.9%	99.9%
Standard 53					
MTBE	0.015 + 20%	0.005 mg/L		74.6%	83.3%
Cyst ^t	Minimum 50,000/L		99.95%	99.99%	99.99%
Turbidity	11 mg/L + 1 NTU	0.5 NTU		96.6%	98.0%
Lead (pH 6.5)	0.15 mg/L + 10%	0.010 mg/L		99.3%	99.3%
Lead (pH 8.5)	0.15 mg/L + 10%	0.010 mg/L		99.3%	99.3%
Mercury (pH 6.5)	0.006 mg/L + 10%	0.002 mg/L		96.6%	96.6%
Mercury (pH 8.5)	0.006 mg/L + 10%	0.002 mg/L		72.4%	95.4%
Chloroform (VOC surrogate chemical)	0.300 mg/L + 10%	0.015 mg/L		95.2%	91.0%

Flow Rate = 0.5 gpm (1.89 Lpm)

Capacity = 1,000 gallons (3786 L)

^t Based on the use of microspheres or *Cryptosporidium parvum* oocysts

Testing was performed under standard laboratory conditions, actual performance may vary

Organic Chemicals Included in Surrogate Testing:

Applies to Total Defense (TD) only

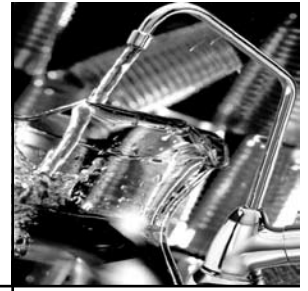

Organic Chemicals Included in Surrogate Testing:

Applies to Total Defense (TD) only.

Substance	Influent Challenge Concentration mg/L	Maximum permissible product water concentration mg/L
alachor	0.050	0.001
atrazine	0.100	0.003
benzene	0.081	0.001
carbofuran	0.190	0.001
carbon tetrachloride	0.078	0.002
chlorbenzene	0.077	0.001
chlorpicrin	0.015	0.000
2,4-D	0.110	0.002
dibromochloropropane (DBCP)	0.052	0.000
o-dichlorobenzene	0.080	0.001
p-dichlorobenzene	0.040	0.001
1,2-dichloroethane	0.088	0.005
1,1-dichloroethylene	0.083	0.001
cis-1,2-dichloroethylene	0.170	0.001
trans-1,2-dichloroethylene	0.086	0.001
1,2-dichloropropane	0.080	0.001
cis-1,3dichloropropylene	0.079	0.001
dinoseb	0.170	0.000
endrin	0.053	0.001
ethylbenzene	0.088	0.001
ethylene dibromide (EDB)	0.044	0.000
haloacetonitriles (HAN):		
bromochloroacetonitrile	0.022	0.001
dibromoacetonitrile	0.024	0.001
dichloroacetonitrile	0.001	0.000
trichloroacetonitrile	0.015	0.000
haloketones (HK):		
1,1-dichloro-2-propane	0.007	0.000
1,1,1-trichloro-2-propane	0.008	0.000
heptachlor	0.250	0.000
heptachlor epoxide	0.011	0.000
hexachlorobutadiene	0.044	0.001
hexachlorocyclopentadiene	0.060	0.000
lindane	0.055	0.000
methoxychlor	0.050	0.000
pentachloophenol	0.096	0.001

Performance Data Sheet (con't)



**Performance
Data Sheet
(con't)**

Substance	Influent Challenge Concentration mg/L	Maximum permissible product water concentration mg/L
simazine	0.120	0.004
styrene	0.150	0.001
1,1,2,2-tetrachloroethane	0.081	0.001
tetrachloroethylene	0.081	0.001
toluene	0.078	0.001
2,4,5-TP (silvex)	0.270	0.002
tribromoacetic acid	0.042	0.001
1,2,4-trichlorobenzene	0.160	0.001
1,1,1-trichloroethane	0.084	0.005
1,1,2-trichloroethane	0.150	0.001
trichloroethylene	0.180	0.001
trihalomethanes (includes):		
chloroform (surrogate chemical)		
bromoform	0.300	0.015
bromodichloromethane		
chlorodibromomethane		
xylenes (total)	0.070	0.001



Performance Data Sheet (con't)

RO30 with AS3

These systems have been tested and certified by NSF International according to NSF/ANSI 53 and 58 for the reduction of the substances listed below. The concentration of the indicated substances in water entering the system was reduced to a concentration less than or equal to the permissible limit for water leaving the system, as specified in NSF/ANSI 53 and 58.

This system is acceptable for treatment of influent concentrations of no more than 27 mg/L nitrate and 3 mg/L nitrite in combination measured as N and is certified for nitrate/nitrite reduction only for water supplies with a pressure of 280 kPa (40 psig) or greater.

Substance Reduction¹

Substance	Influent Challenge Concentration mg/L	Maximum Permissible Product water Concentration mg/L	Reduction Requirements	Minimum Reduction	Average Reduction
Arsenic (pentavalent) ²	0.050 +/- 10%	0.01			97.4%
Barium	10.0 +/- 10%	2			93.8%
Cadmium	0.03 +/- 10%	0.005			98.7%
Hexavalent Chromium	0.30 +/- 10%	0.05			91.2%
Trivalent Chromium	0.30 +/- 10%	0.05			94.8%
Copper	3.00 +/- 10%	1.3			98.9%
Fluoride	8.0 +/- 10%	1.5			95.6%
Lead	0.15 +/- 10%	0.010			98.7%
Nitrate/Nitrite (both as N)	30 +/- 10%			83.1%	86.8%
Nitrate ⁵	27.0 +/- 10%	10.0		83.4%	87.0%
Nitrite	3.0 +/- 10%	1.0		79.5%	84.8%
Radium 226/2283	25pCi/L +/- 10%	5pCi/L			80.0%
Selenium	0.10 +/- 10%	0.05			96.0%
Cyst ⁴	>50,000/mL		99.95%	99.99%	99.99%
Turbidity	11 +/- 1 NTU	0.5 NTU			99.00%

¹ While testing was performed under standard laboratory conditions, actual performance may vary depending on water pressure, temperatures and other substances, which may be found in your water.

² This system has been tested for the treatment of water containing pentavalent arsenic (also known as As(V), As(+5) or arsenate) at concentrations of 0.050 mg/L or less. This system reduces pentavalent arsenic, but may not remove other forms of arsenic. This system is to be used on water supplies containing a detectable free chlorine residual at the system inlet or on water supplies that have been demonstrated to contain only pentavalent arsenic. Treatment with chloramines (combined chlorine) is not sufficient to ensure complete conversion of trivalent arsenic to pentavalent arsenic. Please see the Arsenic Facts Sheet for further information.

³ Based upon testing methods using Barium as a surrogate. All concentrations in pCi/L pico curie/L.

⁴ Includes Giardia lamblia, Entamoeba histolyca and Cryptosporidium.

⁵ Units are not certified on water supplies with a pressure less than 40 psi (280 kPa). A booster pump is strongly recommended.



**Performance
Data Sheet
(con't)**

AS3

The AS3 has been tested according to NSF/ANSI 53 for the reduction of the substances listed below. The concentration of the indicated substances in the water entering the system was reduced to a concentration less than or equal to the permissible limit for water leaving the system, as specified in NSF/ANSI 53. Conforms to NSF/ANSI Standard 53 for arsenic (trivalent and pentavalent) reduction. See Arsenic Fact section for an explanation of reduction performance.

Substance	Influent Challenge Concentration mg/L	Maximum Permissible Product water Concentration mg/L	Reduction Requirements	Minimum Reduction	Average Reduction
Standard 53					
Trivalent Arsenic pH 6.5	0.050 + 10%	0.010			94.9%
Trivalent Arsenic pH 8.5	0.050 + 10%	0.010			98.0%
Pentavalent Arsenic	0.050 + 10%	0.010			97.4%

Flow Rate = 0.035 gpm (0.13 Lpm)
 Capacity = 1000 gallons (3786 L)
 1000 gallon capacity is only for use with PID
 Testing was performed under standard laboratory conditions, actual performance may vary



Performance Data Sheet (con't)

RO30 with AS3, TD

These systems have been tested and certified by NSF International according to NSF/ANSI 42, 53, and 58 for the reduction of the substances listed below. The concentration of the indicated substances in water entering the system was reduced to a concentration less than or equal to the permissible limit for water leaving the system, as specified in NSF/ANSI 42, 53, and 58.

This system is acceptable for treatment of influent concentrations of no more than 27 mg/L nitrate and 3 mg/L nitrite in combination measured as N and is certified for nitrate/nitrite reduction only for water supplies with a pressure of 280 kPa (40 psig) or greater.

Substance Reduction¹

Substance	Influent Challenge Concentration mg/L	Maximum Permissible Product water Concentration mg/L	Reduction Requirements	Minimum Reduction	Average Reduction
Arsenic (pentavalent) ²	0.050 +/- 10%	0.01			97.4%
Barium	10.0 +/- 10%	2			93.8%
Cadmium	0.03 +/- 10%	0.005			98.7%
Hexavalent Chromium	0.30 +/- 10%	0.05			91.2%
Trivalent Chromium	0.30 +/- 10%	0.05			94.8%
Copper	3.00 +/- 10%	1.3			98.9%
Fluoride	8.0 +/- 10%	1.5			95.6%
Lead	0.15 +/- 10%	0.010			98.7%
Nitrate/Nitrite (both as N)	30 +/- 10%			83.1%	86.8%
Nitrate ⁵	27.0 +/- 10%	10.0		83.4%	87.0%
Nitrite	3.0 +/- 10%	1.0		79.5%	84.8%
Radium 226/2283	25pCi/L +/- 10%	5pCi/L			80.0%
Selenium	0.10 +/- 10%	0.05			96.0%
Cyst ⁴	>50,000/mL		99.95%	99.99%	99.99%
Turbidity	11 +/- 1 NTU	0.5 NTU			99.00%

¹ While testing was performed under standard laboratory conditions, actual performance may vary depending on water pressure, temperatures and other substances, which may be found in your water.

² This system has been tested for the treatment of water containing pentavalent arsenic (also known as As(V), As(+5) or arsenate) at concentrations of 0.050 mg/L or less. This system reduces pentavalent arsenic, but may not remove other forms of arsenic. This system is to be used on water supplies containing a detectable free chlorine residual at the system inlet or on water supplies that have been demonstrated to contain only pentavalent arsenic. Treatment with chloramines (combined chlorine) is not sufficient to ensure complete conversion of trivalent arsenic to pentavalent arsenic. Please see the Arsenic Facts Sheet for further information.

³ Based upon testing methods using Barium as a surrogate. All concentrations in pCi/L pico curie/L.

⁴ Includes Giardia lamblia, Entamoeba histolyca and Cryptosporidium.

⁵ Units are not certified on water supplies with a pressure less than 40 psi (280 kPa). A booster pump is strongly recommended.



**Performance
Data Sheet
(con't)**

AS3

The AS3 has been tested according to NSF/ANSI 53 for the reduction of the substances listed below. The concentration of the indicated substances in the water entering the system was reduced to a concentration less than or equal to the permissible limit for water leaving the system, as specified in NSF/ANSI 53. Conforms to NSF/ANSI Standard 53 for arsenic (trivalent and pentavalent) reduction. See Arsenic Fact section for an explanation of reduction performance.

Substance	Influent Challenge Concentration mg/L	Maximum Permissible Product water Concentration mg/L	Reduction Requirements	Minimum Reduction	Average Reduction
Standard 53					
Trivalent Arsenic pH 6.5	0.050 + 10%	0.010			94.9%
Trivalent Arsenic pH 8.5	0.050 + 10%	0.010			98.0%
Pentavalent Arsenic	0.050 + 10%	0.010			97.4%

Flow Rate = 0.035 gpm (0.13 Lpm)
 Capacity = 1000 gallons (3786 L)
 1000 gallon capacity is only for use with PID
 Testing was performed under standard laboratory conditions, actual performance may vary

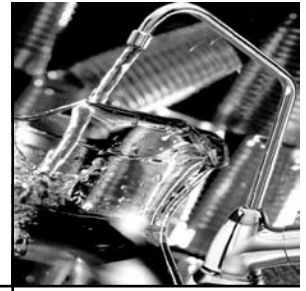

Performance Data Sheet (con't)

Total Defense (TD)

The Total Defense has been tested according to NSF/ANSI 42 and 53 for the reduction of the substances listed below. The concentration of the indicated substances in the water entering the system was reduced to a concentration less than or equal to the permissible limit for water leaving the system, as specified in NSF/ANSI 42 and 53.

Substance Reduction¹

Substance	Influent Challenge Concentration mg/L	Maximum Permissible Product water Concentration mg/L	Reduction Requirements	Minimum Reduction	Average Reduction
Standard 42					
Aesthetic Chlorine	2.0 mg/L + 10%		>50%	97.6%	98.0%
Chloramines	3.0 mg/L + 10%	0.5 mg/L		97.6%	98.0%
Particulate (0.5 - < um) Class I	at least 10,000 particles/mL		>85%	99.9%	99.9%
Standard 53					
MTBE	0.015 + 20%	0.005 mg/L	69%	74.6%	83.3%
Cyst †	Minimum 50,000/L		99.95%	99.95%	99.99%
Turbidity	11 mg/L + 1 NTU	0.5 NTU		96.6%	98.0%
Lead (pH 6.5)	0.15 mg/L + 10%	0.010 mg/L		99.3%	99.3%
Lead (pH 8.5)	0.15 mg/L + 10%	0.010 mg/L		99.3%	99.3%
Mercury (pH 6.5)	0.006 mg/L + 10%	0.002 mg/L		96.6%	96.6%
Mercury (pH 8.5)	0.006 mg/L + 10%	0.002 mg/L		72.4%	95.4%
Chloroform (VOC surrogate chemical)	0.300 mg/L + 10%	0.015 mg/L		95.2%	91.0%

Flow Rate = 0.5 gpm (1.89 Lpm)

Capacity = 1,000 gallons (3786 L)

† Based on the use of microspheres or *Cryptosporidium parvum* oocysts

Testing was performed under standard laboratory conditions, actual performance may vary

Organic Chemicals Included in Surrogate Testing:

Applies to Total Defense (TD) only



**Performance
Data Sheet
(con't)**

Organic Chemicals Included in Surrogate Testing:

Applies to Total Defense (TD) only.

Substance	Influent Challenge Concentration mg/L	Maximum permissible product water concentration mg/L
alachor	0.050	0.001
atrazine	0.100	0.003
benzene	0.081	0.001
carbofuran	0.190	0.001
carbon tetrachloride	0.078	0.002
chlorbenzene	0.077	0.001
chlorpicrin	0.015	0.000
2,4-D	0.110	0.002
dibromochloropropane (DBCP)	0.052	0.000
o-dichlorobenzene	0.080	0.001
p-dichlorobenzene	0.040	0.001
1,2-dichloroethane	0.088	0.005
1,1-dichloroethylene	0.083	0.001
cis-1,2-dichloroethylene	0.170	0.001
trans-1,2-dichloroethylene	0.086	0.001
1,2-dichloropropane	0.080	0.001
cis-1,3dichloropropylene	0.079	0.001
dinoseb	0.170	0.000
endrin	0.053	0.001
ethylbenzene	0.088	0.001
ethylene dibromide (EDB)	0.044	0.000
haloacetonitriles (HAN):		
bromochloroacetonitrile	0.022	0.001
dibromoacetonitrile	0.024	0.001
dichloroacetonitrile	0.001	0.000
trichloroacetonitrile	0.015	0.000
haloketones (HK):		
1,1-dichloro-2-propane	0.007	0.000
1,1,1-trichloro-2-propane	0.008	0.000
heptachlor	0.250	0.000
heptachlor epoxide	0.011	0.000
hexachlorobutadiene	0.044	0.001
hexachlorocyclopentadiene	0.060	0.000
lindane	0.055	0.000
methoxychlor	0.050	0.000
pentachloophenol	0.096	0.001

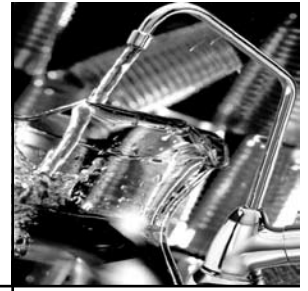

**Performance
Data Sheet
(con't)**

Substance	Influent Challenge Concentration mg/L	Maximum permissible product water concentration mg/L
simazine	0.120	0.004
styrene	0.150	0.001
1,1,2,2-tetrachloroethane	0.081	0.001
tetrachloroethylene	0.081	0.001
toluene	0.078	0.001
2,4,5-TP (silvex)	0.270	0.002
tribromoacetic acid	0.042	0.001
1,2,4-trichlorobenzene	0.160	0.001
1,1,1-trichloroethane	0.084	0.005
1,1,2-trichloroethane	0.150	0.001
trichloroethylene	0.180	0.001
trihalomethanes (includes):		
chloroform (surrogate chemical)		
bromoform	0.300	0.015
bromodichloromethane		
chlorodibromomethane		
xylenes (total)	0.070	0.001



**Performance
Data Sheet
(con't)**

RO50

This system has been tested according to NSF/ANSI 58 for the reduction of the substances listed below. The concentration of the indicated substances in water entering the system was reduced to a concentration less than or equal to the permissible limit for water leaving the system, as specified in NSF/ANSI 58.

This system is acceptable for treatment of influent concentrations of no more than 27 mg/L nitrate and 3 mg/L nitrite in combination measured as N and is certified for nitrate/nitrite reduction only for water supplies with a pressure of 280 kPa (40 psig) or greater.

Substance Reduction¹

Substance	Influent Challenge Concentration mg/L	Maximum Permissible Product water Concentration mg/L	Reduction Requirements	Minimum Reduction	Average Reduction
Arsenic (Pentavalent) ²	0.30 +/- 10%	0.01			99.3%
Barium	10.0 +/- 10%	2			98.5%
Cadmium	0.03 +/- 10%	0.005			98.1%
Hexavalent Chromium	0.30 +/- 10%	0.05			97.7%
Trivalent Chromium	0.30 +/- 10%	0.05			99.0%
Copper	3.00 +/- 10%	1.3			98.7%
Fluoride	8.0 +/- 10%	1.5			95.5%
Lead	0.15 +/- 10%	0.010			98.1%
Nitrate/Nitrite (both as N)	30 +/- 10%			65.9%	68.9%
Nitrate ⁵	27.0 +/- 10%	10.0		66.2%	68.5%
Nitrite	3.0 +/- 10%	1.0		65.5%	69.8%
Radium 226/228 ³	25pCi/L +/- 10%	5pCi/L			80.0%
Selenium	0.10 +/- 10%	0.05			94.0%
Cyst ⁴	>50,000/mL		99.95%	99.99%	99.99%
Turbidity	11 +/- 1 NTU	0.5 NTU			99.3%

¹ While testing was performed under standard laboratory conditions, actual performance may vary depending on water pressure, temperatures and other substances, which may be found in your water.

² This system has been tested for the treatment of water containing pentavalent arsenic (also known as As(V), As(+5) or arsenate) at concentrations of 0.30 mg/L or less. This system reduces pentavalent arsenic, but may not remove other forms of arsenic. This system is to be used on water supplies containing a detectable free chlorine residual at the system inlet or on water supplies that have been demonstrated to contain only pentavalent arsenic. Treatment with chloramines (combined chlorine) is not sufficient to ensure complete conversion of trivalent arsenic to pentavalent arsenic. Please see the Arsenic Facts Sheet for further information.

³ Based upon testing methods using Barium as a surrogate. All concentrations in pCi/L pico curie/L.

⁴ Includes Giardia lamblia, Entamoeba histolyca and Cryptosporidium.

⁵ Units are not certified on water supplies with a pressure less than 40 psi (280 kPa). A booster pump is strongly recommended.



Performance Data Sheet (con't)

RO50 with TD

These systems have been tested and certified by NSF International according to NSF/ANSI 42, 53, and 58 for the reduction of the substances listed below. The concentration of the indicated substances in water entering the system was reduced to a concentration less than or equal to the permissible limit for water leaving the system, as specified in NSF/ANSI 42, 53, and 58.

This system is acceptable for treatment of influent concentrations of no more than 27 mg/L nitrate and 3 mg/L nitrite in combination measured as N and is certified for nitrate/nitrite reduction only for water supplies with a pressure of 280 kPa (40 psig) or greater.

Substance Reduction¹

Substance	Influent Challenge Concentration mg/L	Maximum Permissible Product water Concentration mg/L	Reduction Requirements	Minimum Reduction	Average Reduction
Arsenic (pentavalent) ²	0.30 +/- 10%	0.01			99.3%
Barium	10.0 +/- 10%	2			98.5%
Cadmium	0.03 +/- 10%	0.005			98.1%
Hexavalent Chromium	0.30 +/- 10%	0.05			97.7%
Trivalent Chromium	0.30 +/- 10%	0.05			99.0%
Copper	3.00 +/- 10%	1.3			98.7%
Fluoride	8.0 +/- 10%	1.5			95.5%
Lead	0.15 +/- 10%	0.010			98.1%
Nitrate/Nitrite (both as N)	30 +/- 10%			65.9%	68.9%
Nitrate ⁵	27.0 +/- 10%	10.0		66.2%	68.5%
Nitrite	3.0 +/- 10%	1.0		65.5%	69.8%
Radium 226/2283	25pCi/L +/- 10%	5pCi/L			80.0%
Selenium	0.10 +/- 10%	0.05			94.0%
Cyst ⁴	>50,000/mL		99.95%	99.99%	99.99%
Turbidity	11 +/- 1 NTU	0.5 NTU			99.3%

¹ While testing was performed under standard laboratory conditions, actual performance may vary depending on water pressure, temperatures and other substances, which may be found in your water.

² This system has been tested for the treatment of water containing pentavalent arsenic (also known as As(V), As(+5) or arsenate) at concentrations of 0.30 mg/L or less. This system reduces pentavalent arsenic, but may not remove other forms of arsenic. This system is to be used on water supplies containing a detectable free chlorine residual at the system inlet or on water supplies that have been demonstrated to contain only pentavalent arsenic. Treatment with chloramines (combined chlorine) is not sufficient to ensure complete conversion of trivalent arsenic to pentavalent arsenic. Please see the Arsenic Facts Sheet for further information.

³ Based upon testing methods using Barium as a surrogate. All concentrations in pCi/L pico curie/L.

⁴ Includes Giardia lamblia, Entamoeba histolyca and Cryptosporidium.

⁵ Units are not certified on water supplies with a pressure less than 40 psi (280 kPa). A booster pump is strongly recommended..



Performance Data Sheet (con't)

Total Defense (TD)

The Total Defense has been tested according to NSF/ANSI 42 and 53 for the reduction of the substances listed below. The concentration of the indicated substances in the water entering the system was reduced to a concentration less than or equal to the permissible limit for water leaving the system, as specified in NSF/ANSI 42 and 53.

Substance Reduction¹

Substance	Influent Challenge Concentration mg/L	Maximum Permissible Product water Concentration mg/L	Reduction Requirements	Minimum Reduction	Average Reduction
Standard 42					
Chlorine	2.0 mg/L + 10%		>50%	97.6%	98.0%
Chloramines	3.0 mg/L + 10%	0.5 mg/L		97.6%	98.0%
Particulate (0.5 - < um) Class I	at least 10,000 particles/mL		>85%	99.9%	99.9%
Standard 53					
MTBE	0.015 + 20%	0.005 mg/L	69%	74.6%	83.3%
Cyst t	Minimum 50,000/L		99.95%	99.95%	99.99%
Turbidity	11 mg/L + 1 NTU	0.5 NTU		96.6%	98.0%
Lead (pH 6.5)	0.15 mg/L + 10%	0.010 mg/L		99.3%	99.3%
Lead (pH 8.5)	0.15 mg/L + 10%	0.010 mg/L		99.3%	99.3%
Mercury (pH 6.5)	0.006 mg/L + 10%	0.002 mg/L		96.6%	96.6%
Mercury (pH 8.5)	0.006 mg/L + 10%	0.002 mg/L		72.4%	95.4%
Chloroform (VOC surrogate chemical)	0.300 mg/L + 10%	0.015 mg/L		95.2%	91.0%

Flow Rate = 0.5 gpm (1.89 Lpm)
 Capacity = 1,000 gallons (3786 L)
 t Based on the use of microspheres or *Cryptosporidium parvum* oocysts
 Testing was performed under standard laboratory conditions, actual performance may vary
 Organic Chemicals Included in Surrogate Testing:
 Applies to Total Defense (TD) only



**Performance
Data Sheet
(con't)**

Organic Chemicals Included in Surrogate Testing:

Applies to Total Defense (TD) only.

Substance	Influent Challenge Concentration mg/L	Maximum permissible product water concentration mg/L
alachor	0.050	0.001
atrazine	0.100	0.003
benzene	0.081	0.001
carbofuran	0.190	0.001
carbon tetrachloride	0.078	0.002
chlorbenzene	0.077	0.001
chlorpicrin	0.015	0.000
2,4-D	0.110	0.002
dibromochloropropane (DBCP)	0.052	0.000
o-dichlorobenzene	0.080	0.001
p-dichlorobenzene	0.040	0.001
1,2-dichloroethane	0.088	0.005
1,1-dichloroethylene	0.083	0.001
cis-1,2-dichloroethylene	0.170	0.001
trans-1,2-dichloroethylene	0.086	0.001
1,2-dichloropropane	0.080	0.001
cis-1,3dichloropropylene	0.079	0.001
dinoseb	0.170	0.000
endrin	0.053	0.001
ethylbenzene	0.088	0.001
ethylene dibromide (EDB)	0.044	0.000
haloacetonitriles (HAN):		
bromochloroacetonitrile	0.022	0.001
dibromoacetonitrile	0.024	0.001
dichloroacetonitrile	0.001	0.000
trichloroacetonitrile	0.015	0.000
haloketones (HK):		
1,1-dichloro-2-propane	0.007	0.000
1,1,1-trichloro-2-propane	0.008	0.000
heptachlor	0.250	0.000
heptachlor epoxide	0.011	0.000
hexachlorobutadiene	0.044	0.001
hexachlorocyclopentadiene	0.060	0.000



**Performance
Data Sheet
(con't)**

lindane	0.055	0.000
methoxychlor	0.050	0.000
pentachloophenol	0.096	0.001
simazine	0.120	0.004
Substance	Influent Challenge Concentration mg/L	Maximum permissible product water concentration mg/L
styrene	0.150	0.001
1,1,2,2-tetrachloroethane	0.081	0.001
tetrachloroethylene	0.081	0.001
toluene	0.078	0.001
2,4,5-TP (silvex)	0.270	0.002
tribromoacetic acid	0.042	0.001
1,2,4-trichlorobenzene	0.160	0.001
1,1,1-trichloroethane	0.084	0.005
1,1,2-trichloroethane	0.150	0.001
trichloroethylene	0.180	0.001
trihalomethanes (includes):		
chloroform (surrogate chemical)		
bromoform	0.300	0.015
bromodichloromethane		
chlorodibromomethane		
xylene (total)	0.070	0.001

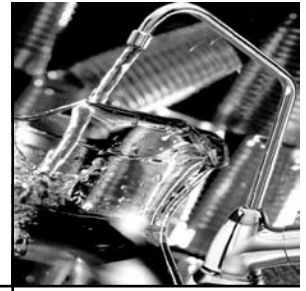

Performance Data Sheet (con't)

RO50 with AS3

These systems have been tested and certified by NSF International according to NSF/ANSI 53 and 58 for the reduction of the substances listed below. The concentration of the indicated substances in water entering the system was reduced to a concentration less than or equal to the permissible limit for water leaving the system, as specified in NSF/ANSI 53 and 58.

This system is acceptable for treatment of influent concentrations of no more than 27 mg/L nitrate and 3 mg/L nitrite in combination measured as N and is certified for nitrate/nitrite reduction only for water supplies with a pressure of 280 kPa (40 psig) or greater.

Substance Reduction¹

Substance	Influent Challenge Concentration mg/L	Maximum Permissible Product water Concentration mg/L	Reduction Requirements	Minimum Reduction	Average Reduction
Arsenic (pentavalent) ²	0.30 +/- 10%	0.01			99.3%
Barium	10.0 +/- 10%	2			98.5%
Cadmium	0.03 +/- 10%	0.005			98.1%
Hexavalent Chromium	0.30 +/- 10%	0.05			97.7%
Trivalent Chromium	0.30 +/- 10%	0.05			99.0%
Copper	3.00 +/- 10%	1.3			98.7%
Fluoride	8.0 +/- 10%	1.5			95.5%
Lead	0.15 +/- 10%	0.010			98.1%
Nitrate/Nitrite (both as N)	30 +/- 10%			65.9%	68.9%
Nitrate ⁵	27.0 +/- 10%	10.0		66.2%	68.5%
Nitrite	3.0 +/- 10%	1.0		65.5%	69.8%
Radium 226/2283	25pCi/L +/- 10%	5pCi/L			80.0%
Selenium	0.10 +/- 10%	0.05			94.0%
Cyst ⁴	>50,000/mL		99.95%	99.99%	99.99%
Turbidity	11 +/- 1 NTU	0.5 NTU			99.3%

¹ While testing was performed under standard laboratory conditions, actual performance may vary depending on water pressure, temperatures and other substances, which may be found in your water.

² This system has been tested for the treatment of water containing pentavalent arsenic (also known as As(V), As(+5) or arsenate) at concentrations of 0.30 mg/L or less. This system reduces pentavalent arsenic, but may not remove other forms of arsenic. This system is to be used on water supplies containing a detectable free chlorine residual at the system inlet or on water supplies that have been demonstrated to contain only pentavalent arsenic. Treatment with chloramines (combined chlorine) is not sufficient to ensure complete conversion of trivalent arsenic to pentavalent arsenic. Please see the Arsenic Facts Sheet for further information.

³ Based upon testing methods using Barium as a surrogate. All concentrations in pCi/L pico curie/L.

⁴ Includes Giardia lamblia, Entamoeba histolyca and Cryptosporidium.

⁵ Units are not certified on water supplies with a pressure less than 40 psi (280 kPa). A booster pump is strongly recommended.



**Performance
Data Sheet
(con't)**

AS3

The AS3 has been tested according to NSF/ANSI 53 for the reduction of the substances listed below. The concentration of the indicated substances in the water entering the system was reduced to a concentration less than or equal to the permissible limit for water leaving the system, as specified in NSF/ANSI 53. Conforms to NSF/ANSI Standard 53 for arsenic (trivalent and pentavalent) reduction. See Arsenic Fact section for an explanation of reduction performance.

Substance	Influent Challenge Concentration mg/L	Maximum Permissible Product water Concentration mg/L	Reduction Requirements	Minimum Reduction	Average Reduction
Standard 53					
Trivalent Arsenic pH 6.5	0.050 + 10%	0.010			94.9%
Trivalent Arsenic pH 8.5	0.050 + 10%	0.010			98.0%
Pentavalent Arsenic	0.050 + 10%	0.010			97.4%

Flow Rate = 0.035 gpm (0.13 Lpm)
 Capacity = 1000 gallons (3786 L)
 1000 gallon capacity is only for use with PID
 Testing was performed under standard laboratory conditions, actual performance may vary

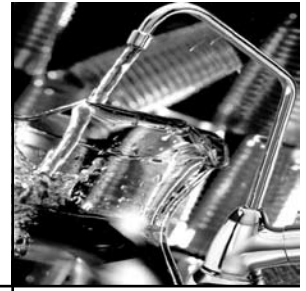

Performance Data Sheet (con't)

RO50 with AS3, TD

These systems have been tested and certified by NSF International according to NSF/ANSI 42, 53, and 58 for the reduction of the substances listed below. The concentration of the indicated substances in water entering the system was reduced to a concentration less than or equal to the permissible limit for water leaving the system, as specified in NSF/ANSI 42, 53, and 58.

This system is acceptable for treatment of influent concentrations of no more than 27 mg/L nitrate and 3 mg/L nitrite in combination measured as N and is certified for nitrate/nitrite reduction only for water supplies with a pressure of 280 kPa (40 psig) or greater.

Substance Reduction¹

Substance	Influent Challenge Concentration mg/L	Maximum Permissible Product water Concentration mg/L	Reduction Requirements	Minimum Reduction	Average Reduction
Arsenic (pentavalent) ²	0.30 +/- 10%	0.01			99.3%
Barium	10.0 +/- 10%	2			98.5%
Cadmium	0.03 +/- 10%	0.005			98.1%
Hexavalent Chromium	0.30 +/- 10%	0.05			97.7%
Trivalent Chromium	0.30 +/- 10%	0.05			99.0%
Copper	3.00 +/- 10%	1.3			98.7%
Fluoride	8.0 +/- 10%	1.5			95.5%
Lead	0.15 +/- 10%	0.010			98.1%
Nitrate/Nitrite (both as N)	30 +/- 10%			65.9%	68.9%
Nitrate ⁵	27.0 +/- 10%	10.0		66.2%	68.5%
Nitrite	3.0 +/- 10%	1.0		65.5%	69.8%
Radium 226/2283	25pCi/L +/- 10%	5pCi/L			80.0%
Selenium	0.10 +/- 10%	0.05			94.0%
Cyst ⁴	>50,000/mL		99.95%	99.99%	99.99%
Turbidity	11 +/- 1 NTU	0.5 NTU			99.3%

¹ While testing was performed under standard laboratory conditions, actual performance may vary depending on water pressure, temperatures and other substances, which may be found in your water.

² This system has been tested for the treatment of water containing pentavalent arsenic (also known as As(V), As(+5) or arsenate) at concentrations of 0.30 mg/L or less. This system reduces pentavalent arsenic, but may not remove other forms of arsenic. This system is to be used on water supplies containing a detectable free chlorine residual at the system inlet or on water supplies that have been demonstrated to contain only pentavalent arsenic. Treatment with chloramines (combined chlorine) is not sufficient to ensure complete conversion of trivalent arsenic to pentavalent arsenic. Please see the Arsenic Facts Sheet for further information.

³ Based upon testing methods using Barium as a surrogate. All concentrations in pCi/L, pico curie/L.

⁴ Includes Giardia lamblia, Entamoeba histolyca and Cryptosporidium.

⁵ Units are not certified on water supplies with a pressure less than 40 psi (280 kPa). A booster pump is strongly recommended.



**Performance
Data Sheet
(con't)**

AS3

The AS3 has been tested according to NSF/ANSI 53 for the reduction of the substances listed below. The concentration of the indicated substances in the water entering the system was reduced to a concentration less than or equal to the permissible limit for water leaving the system, as specified in NSF/ANSI 53. Conforms to NSF/ANSI Standard 53 for arsenic (trivalent and pentavalent) reduction. See Arsenic Fact section for an explanation of reduction performance.

Substance	Influent Challenge Concentration mg/L	Maximum Permissible Product water Concentration mg/L	Reduction Requirements	Minimum Reduction	Average Reduction
Standard 53					
Trivalent Arsenic pH 6.5	0.050 + 10%	0.010			94.9%
Trivalent Arsenic pH 8.5	0.050 + 10%	0.010			98.0%
Pentavalent Arsenic	0.050 + 10%	0.010			97.4%

Flow Rate = 0.035 gpm (0.13 Lpm)
 Capacity = 1000 gallons (3786 L)
 1000 gallon capacity is only for use with PID
 Testing was performed under standard laboratory conditions, actual performance may vary



Performance Data Sheet (con't)

Total Defense (TD)

Total Defense has been tested according to NSF/ANSI 42 and 53 for the reduction of the substances listed below. The concentration of the indicated substances in the water entering the system was reduced to a concentration less than or equal to the permissible limit for water leaving the system, as specified in NSF/ANSI 42 and 53.

Substance Reduction¹

Substance	Influent Challenge Concentration mg/L	Maximum Permissible Product water Concentration mg/L	Reduction Requirements	Minimum Reduction	Average Reduction
Standard 42					
Aesthetic Chlorine	2.0 mg/L + 10%		>50%	97.6%	98.0%
Chloramines	3.0 mg/L + 10%	0.5 mg/L		97.6%	98.0%
Particulate (0.5 - < um) Class I	at least 10,000 particles/mL		>85%	99.9%	99.9%
Standard 53					
MTBE	0.015 + 20%	0.005 mg/L	69%	74.6%	83.3%
Cyst t	Minimum 50,000/L		99.95%	99.95%	99.99%
Turbidity	11 mg/L + 1 NTU	0.5 NTU		96.6%	98.0%
Lead (pH 6.5)	0.15 mg/L + 10%	0.010 mg/L		99.3%	99.3%
Lead (pH 8.5)	0.15 mg/L + 10%	0.010 mg/L		99.3%	99.3%
Mercury (pH 6.5)	0.006 mg/L + 10%	0.002 mg/L		96.6%	96.6%
Mercury (pH 8.5)	0.006 mg/L + 10%	0.002 mg/L		72.4%	95.4%
Chloroform (VOC surrogate chemical)	0.300 mg/L + 10%	0.015 mg/L		95.2%	91.0%

Flow Rate = 0.5 gpm (1.89 Lpm)

Capacity = 1,000 gallons (3786 L)

^t Based on the use of microspheres or *Cryptosporidium parvum* oocysts

Testing was performed under standard laboratory conditions, actual performance may vary

Organic Chemicals Included in Surrogate Testing:

Applies to Total Defense (TD) only



**Performance
Data Sheet
(con't)**

Organic Chemicals Included in Surrogate Testing:

Applies to Total Defense (TD) only.

Substance	Influent Challenge Concentration mg/L	Maximum permissible product water concentration mg/L
alachor	0.050	0.001
atrazine	0.100	0.003
benzene	0.081	0.001
carbofuran	0.190	0.001
carbon tetrachloride	0.078	0.002
chlorbenzene	0.077	0.001
chlorpicrin	0.015	0.000
2,4-D	0.110	0.002
dibromochloropropane (DBCP)	0.052	0.000
o-dichlorobenzene	0.080	0.001
p-dichlorobenzene	0.040	0.001
1,2-dichloroethane	0.088	0.005
1,1-dichloroethylene	0.083	0.001
cis-1,2-dichloroethylene	0.170	0.001
trans-1,2-dichloroethylene	0.086	0.001
1,2-dichloropropane	0.080	0.001
cis-1,3dichloropropylene	0.079	0.001
dinoseb	0.170	0.000
endrin	0.053	0.001
ethylbenzene	0.088	0.001
ethylene dibromide (EDB)	0.044	0.000
haloacetonitriles (HAN):		
bromochloroacetonitrile	0.022	0.001
dibromoacetonitrile	0.024	0.001
dichloroacetonitrile	0.001	0.000
trichloroacetonitrile	0.015	0.000
haloketones (HK):		
1,1-dichloro-2-propane	0.007	0.000
1,1,1-trichloro-2-propane	0.008	0.000
heptachlor	0.250	0.000
heptachlor epoxide	0.011	0.000
hexachlorobutadiene	0.044	0.001
hexachlorocyclopentadiene	0.060	0.000
lindane	0.055	0.000
methoxychlor	0.050	0.000
pentachloophenol	0.096	0.001



**Performance
Data Sheet
(con't)**

Substance	Influent Challenge Concentration mg/L	Maximum permissible product water concentration mg/L
simazine	0.120	0.004
styrene	0.150	0.001
1,1,2,2-tetrachloroethane	0.081	0.001
tetrachloroethylene	0.081	0.001
toluene	0.078	0.001
2,4,5-TP (silvex)	0.270	0.002
tribromoacetic acid	0.042	0.001
1,2,4-trichlorobenzene	0.160	0.001
1,1,1-trichloroethane	0.084	0.005
1,1,2-trichloroethane	0.150	0.001
trichloroethylene	0.180	0.001
trihalomethanes (includes):		
chloroform (surrogate chemical)		
bromoform	0.300	0.015
bromodichloromethane		
chlorodibromomethane		
xylenes (total)	0.070	0.001



**Performance
Data Sheet
(con't)**

Output (Total Dissolved Solids (TDS) Reduction and Output Production)¹ – RO30

Tank Size	2 gallon	3 gallon	9 gallon
Product System Daily Prod. Rate To Pressurized Storage Tank	11.09 gpd	11.09 gpd	11.09 gpd
Prod. Rate without Storage Tank To Atmosphere	36 gpd	36 gpd	36 gpd
Efficiency Rating ²	16.86%	16.86%	16.86%
Recovery Rating ³	28.84%	28.84%	28.84%
Influent Challenge Concentration (Mg/L)	770	770	770
Max. Permissible Product Water Concentration (Mg/L)	187	187	187
Minimum Percent Removal	93.1%	93.1%	93.1%
Average Percent Removal	95.4%	95.4%	95.4%

- 1 This is a factory specification for membrane production. Actual production rate and TDS rejection will depend on temperature, water pressure, TDS level, membrane variation and usage pattern.
 2 Efficiency rating means the percentage of the influent water to the system that is available to the user are reverse osmosis treated water under operating conditions that approximate daily usage.
 3 Recovery rating means the percentage of the influent water to the membrane portion of the system that is available to the user as reverse osmosis treated water when the system is operated without a storage tank or when the storage tank is bypassed.

Output (Total Dissolved Solids (TDS) Reduction and Output Production)¹ – RO50

Tank Size	2 gallon	3 gallon	9 gallon
Product System Daily Prod. Rate To Pressurized Storage Tank	16.16 gpd	16.16 gpd	16.16 gpd
Prod. Rate without Storage Tank To Atmosphere	50 gpd	50 gpd	50 gpd
Efficiency Rating ²	18.98%	18.98%	18.98%
Recovery Rating ³	31.37%	31.37%	31.37%
Influent Challenge Concentration (Mg/L)	770	770	770
Max. Permissible Product Water Concentration (Mg/L)	187	187	187
Minimum Percent Removal	86.6%	86.6%	86.6%
Average Percent Removal	92.3%	92.3%	92.3%

- 1 This is a factory specification for membrane production. Actual production rate and TDS rejection will depend on temperature, water pressure, TDS level, membrane variation and usage pattern.
 2 Efficiency rating means the percentage of the influent water to the system that is available to the user are reverse osmosis treated water under operating conditions that approximate daily usage.
 3 Recovery rating means the percentage of the influent water to the membrane portion of the system that is available to the user as reverse osmosis treated water when the system is operated without a storage tank or when the storage tank is bypassed.

Testing Conditions (Complete System)

Temperature: 77° F + 2° F

pH: 7.5 + 0.5

Pressure: 50 psi

Turbidity: <1 NTU

This system has been tested and shown to operate at its calculated recovery rating under standard laboratory conditions.

This reverse osmosis system contains a replaceable component critical to the efficiency of the system. Replacement of the reverse osmosis component should be with one of identical specifications, as defined by the manufacturer, to assure the same efficiency and contaminant reduction performance.

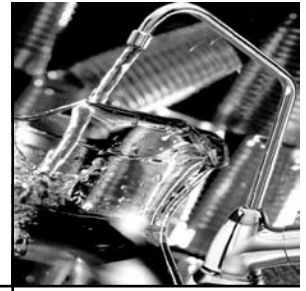

Performance Data Sheet (con't)

AS3

The AS3 has been tested according to NSF/ANSI 53 for the reduction of the substances listed below. The concentration of the indicated substances in the water entering the system was reduced to a concentration less than or equal to the permissible limit for water leaving the system, as specified in NSF/ANSI 53. Conforms to NSF/ANSI Standard 53 for arsenic (trivalent and pentavalent) reduction. See Arsenic Fact section for an explanation of reduction performance.

Substance Reduction

Substance	Influent Challenge Concentration mg/L	Maximum Permissible Product water Concentration mg/L	Reduction Requirements	Minimum Reduction	Average Reduction
Standard 53					
Trivalent Arsenic pH 6.5	0.050 + 10%	0.010			94.9%
Trivalent Arsenic pH 8.5	0.050 + 10%	0.010			98.0%
Pentavalent Arsenic	0.050 + 10%	0.010			97.4%

Flow Rate = 0.035 gpm (0.13 Lpm)
 Capacity = 1000 gallons (3786 L)
 1000 gallon capacity is only for use with PID
 Testing was performed under standard laboratory conditions, actual performance may vary.

PER*

The PER has been tested for perchlorate reduction with an average influent of 103 ug/L and an average effluent of <1ug/L as tested by NSF International.

Substance Reduction

Substance	Influent Challenge Concentration mg/L	Maximum Permissible Product water Concentration mg/L	Reduction Requirements	Minimum Reduction	Average Reduction
Perchlorate	0.10 + 10%	0.006			99.0%

Flow Rate = 0.035 gpm (0.13 Lpm)
 Capacity = 1000 gallons (3786 L)
 Testing was performed under standard laboratory conditions, actual performance may vary.

* Cartridge not for sale in California.



Performance Data Sheet (con't)

The Aqua-Cleer Advanced Drinking Water System with CB or GAC cartridge has been tested and certified by NSF International against NSF/ANSI Standard 42 for the effective reduction of aesthetic Chlorine Taste and Odor, the TD cartridge for the effective reduction of aesthetic Chlorine Taste and Odor and Nominal Particulate Class 1 and against CSA B483.1.



The Aqua-Cleer Advanced Drinking Water System with TD cartridge has been tested and certified by NSF International against NSF/ANSI Standard 53 for the effective reduction of Cyst, Lead, Mercury, VOC, MTBE and Turbidity and against CSA B483.1.

The Aqua-Cleer Advanced Drinking Water System with RO30 or RO50 has been tested and certified by NSF International against NSF/ANSI Standard 58 for the effective reduction of TDS, pentavalent arsenic, barium, cadmium, hexavalent and trivalent chromium, copper, lead, nitrate/nitrite, radium 226/228 and selenium. The concentration of the indicated substances in water entering the system was reduced to a concentration less than or equal to the permissible limit for water leaving the system as specified in NSF/ANSI 58 and against CSA B483.1.

The Aqua-Cleer Advanced Drinking Water System with AS3 has been tested and certified by NSF International against NSF/ANSI Standard 53 for the effective reduction of arsenic (trivalent and pentavalent) when following an RO and against CSA B483.1.

Refer to your Installation and Operating Instructions and printed limited Warranties for more specific product information. To avoid contamination from improper handling and installation, your system should only be installed and serviced by your Culligan Man. Performance will vary based on local water conditions. The substances reduced by these systems are not necessarily in your water.



**California
Certificates**

CA Certificates - Placeholder



California Certificates

CA Certificates - Placeholder



**California
Certificates**

CA Certificates - Placeholder



California Certificates

CA Certificates - Placeholder



CA Certificates - Placeholder

California Certificates



California Certificates

CA Certificates - Placeholder



CA Certificates - Placeholder

California Certificates



California Certificates

CA Certificates - Placeholder



**California
Certificates**

CA Certificates - Placeholder



Arsenic Fact Sheet

Arsenic (abbreviated As) is found naturally in some well water. Arsenic in water has no color, taste or odor. It must be measured by a lab test. Public water utilities must have their water tested for arsenic. You can get the results from your water utility. If you have your own well, you can have the water tested. The local health department or the state environmental health agency can provide a list of certified labs. The cost is typically \$15 - \$30. Information about arsenic in water can be found on the internet at the US Environmental Protection Agency website: www.epa.gov/safe_water/arsenic.html.

There are two forms of arsenic: pentavalent arsenic (also called As (v), As (+5), and arsenate) and trivalent arsenic (also called As (III), As (+3), and arsenite). In well water, arsenic may be pentavalent, trivalent, or a combination of both. Special sampling procedures are needed for a lab to determine what type and how much of each type of arsenic is in the water. Check with the labs in your area to see if they can provide this type of service.

Reverse osmosis (RO) water treatment systems do not remove trivalent arsenic from water very well. RO systems are very effective at removing pentavalent arsenic. A free chlorine residual will rapidly convert trivalent arsenic to pentavalent arsenic. Other water treatment chemicals such as ozone and potassium permanganate will also change trivalent arsenic to pentavalent arsenic. A combined chlorine residual (also called chloramine) may not convert all the trivalent arsenic. If you get water from a public water utility, contact the utility to find out if free chlorine or combined chlorine is used in the water system.

The Aqua-Clear system is designed to remove pentavalent arsenic. It will not convert trivalent arsenic to pentavalent arsenic. The system was tested in a lab. Under those conditions, the system reduced 0.050 mg/L (ppm) pentavalent arsenic to 0.010 mg/L (ppm) (the USEPA standard for drinking water) or less. The performance of the system may be different at your installation. Have the treated water tested for arsenic to check if the system is working properly.

The RO component of the Aqua-Clear system must be replaced every 3-5 years to ensure the system will continue to remove pentavalent arsenic. The component identification and locations where you can purchase the component are listed in the installation/operation manual.

The system has been tested for the treatment of water containing pentavalent arsenic (also known as As (V), As (III), or arsenate) at concentrations of 0.050 mg/L or less. This system reduces pentavalent arsenic, but may not remove other forms of arsenic. This system is to be used on water supplies containing a detectable free chlorine residual or on water supplies that have been demonstrated to contain only pentavalent arsenic. Treatment with chloramine (combined chlorine) is not sufficient to ensure complete conversion of trivalent arsenic to pentavalent arsenic. Please see the Arsenic Fact section of the Performance data Sheet for further information.

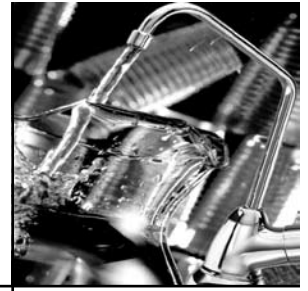

Arsenic Fact Sheet (con't)

Arsenic (As) is a naturally occurring contaminant found in many ground waters. It generally occurs in two forms (valences or oxidation states): pentavalent arsenic (also known as As(V), As(+5), and arsenate) and trivalent arsenic (also known as As(III), As(+3), and arsenite). In natural ground water, arsenic may exist as trivalent arsenic, pentavalent arsenic, or a combination of both. More information about arsenic and its toxicity can be found at the Agency for Toxic Substances and Disease Registry Toxicological Profile on Arsenic website at <http://www.atsdr.cdc.gov/toxprofiles/phs2.html>, and at the U.S. Environmental Protection Agency website at <http://www.epa.gov/safewater/arsenic.html>.

Arsenic does not generally impart color, taste, or smell to water; therefore, it can only be detected by a chemical analytical test. Public water supplies are required to monitor delivered water for arsenic (trivalent arsenic plus pentavalent arsenic) and the results are available to the public from the utility. Consumers using private water sources will need to make arrangements for testing. An arsenic test usually costs about \$15-30, and it is recommended that the test be conducted by a certified laboratory. Local health departments or environmental protection agencies can help provide consumers with a list of certified laboratories. Some laboratories may also be able to analyze specifically for (speciate) the form(s) of arsenic present in a water sample if requested.

The Aqua-Clear system with AS3 following an RO is designed to reduce arsenic: both pentavalent and trivalent forms of arsenic. This treatment system was tested under laboratory condition as defined in NSF/ANSI 53 Drinking Water Treatment Units - Health Effects and was found to reduce [influent arsenic challenge concentration 0.050 mg/L] arsenic consisting of either pentavalent or trivalent arsenic in the test water to less than 0.010 mg/L, for [tested treatment capacity] gallons of delivered water, the life of the system under standard testing conditions. Actual performance of the system may vary depending on specific water quality conditions at the consumer's installation. Following installation of this system, the consumer should have the treated water tested for arsenic to verify that arsenic reduction is being achieved and the system is functioning properly.

The arsenic removal component of this system must be replaced at the end of its useful life of 1,000 gallons. The replacement components, AS3, RO30, RO50 can be purchased from your local Culligan dealer.



**Troubleshooting
Guide**



Troubleshooting Guide (con't)



Service Log

Model _____ Serial No. _____

Date Installed _____

For Service Call Culligan at: (_____) - _____

Cartridge(s) Changed						
Date Serviced	Sediment Filter	Activated Pre-Carbon Filter	RO Membrane	Activated Post-Carbon Filter	Sanitized	Specialty Cartridge

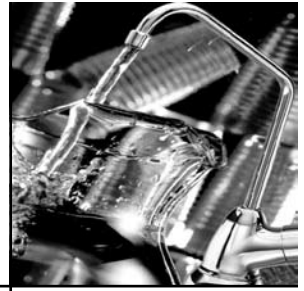

Culligan Lifetime Limited Warranty

Culligan Aqua-Clear Advanced Drinking Water System

You have just purchased one of the finest drinking water systems made. As an expression of our confidence in Culligan products, your drinking water system is warranted to the original end-user, when installed in accordance with Culligan International Company specifications, against defects in material and workmanship from the date of original installation, as follows:

- **For the LIFETIME of the original end-user**
The entire reverse osmosis water conditioning unit, EXCLUDING THE EXPENDABLE FILTER CARTRIDGES AND REVERSE OSMOSIS MEMBRANE FILTER USED IN THE UNIT.
- **For a period of ONE YEAR**
The Culligan brand reverse osmosis membrane filter.

If a part described above is found defective within the specified period, you should notify your independently operated Culligan dealer and arrange a time during normal business hours for the dealer to inspect the drinking water system on your premises. Any part found defective within the terms of this warranty will be repaired or replaced by the dealer. You pay only freight from our factory and local dealer charges.

Damage caused by accident, fire, flood, freezing, Act of God, misuse, misapplication, neglect, alteration, installation or operation contrary to our printed instructions, or by the use of accessories or components which do not meet Culligan specifications, is not covered by this warranty.

Our product performance specifications are furnished with each drinking water system. TO THE EXTENT PERMITTED BY LAW, CULLIGAN DISCLAIMS ALL IMPLIED WARRANTIES INCLUDING, WITHOUT LIMITATION, WARRANTIES OF MERCHANTABILITY AND FITNESS FOR PARTICULAR PURPOSE; TO THE EXTENT REQUIRED BY LAW, ANY SUCH IMPLIED WARRANTIES ARE LIMITED IN DURATION TO THE ONE-YEAR PERIOD SPECIFIED ABOVE FOR THE PARTS DESCRIBED IN THIS LIMITED WARRANTY. As manufacturer, we do not know the characteristics of your water supply or the purpose for which you are purchasing a drinking water system. Please understand that the quality of water supplies may vary seasonally or over a period of time, and that your water usage rate may vary as well. Water characteristics can also change considerably if your drinking water system is moved to a new location. For these reasons, we assume no liability for the determination of the proper equipment necessary to meet your requirements, and we do not authorize others to assume such obligations for us. Further, we assume no liability and extend no warranties, express or implied, for the use of this product on a non-potable water source. OUR OBLIGATIONS UNDER THIS WARRANTY ARE LIMITED TO THE REPAIR OR REPLACEMENT OF THE FAILED PARTS OF THE DRINKING WATER SYSTEM, AND WE ASSUME NO LIABILITY WHATSOEVER FOR DIRECT, INCIDENTAL, CONSEQUENTIAL, SPECIAL, GENERAL, OR OTHER DAMAGES, WHETHER FROM CORROSION OR OTHER CAUSES.

CONSUMERS:

Some states do not allow limitations on how long an implied warranty lasts, so the above limitation may not apply to you. Similarly, some states do not allow the exclusion of incidental or consequential damages, so the above limitation or exclusion may not apply to you. This warranty gives you specific legal rights, and you may also have other rights which vary from state to state. Consult your telephone directory for your local independently-operated Culligan dealer, or write Culligan International Company, for warranty and service information.

Culligan International Company

9399 W. Higgins Road, Suite 1100
Rosemont, Illinois 60018

**This page contains materials and DCO information.
IT DOES NOT PRINT AS PART OF THE DOCUMENT!**

Materials & Description: Aqua-Clear Advanced Drinking Water System Owners Guide 01020485

Size: 11" x 17" Booklet folded to 8.5" x 11"

Color: Black, 2 Sided

Stock: 20# White

Other: Collate, Bookletmaker (Fold to 8 1/2 x 11")

Saddle Stitch with 2 Staples

Standard 3 Hole Drill

Let	Change	By	Appv'd	DCO	Date
A	New Art Created	BSM	LW	010086	10/29/07
A ²	Revisions	BSM	LW	010086	01/07/08
A ³	Revisions	BSM	LW	010086	02/07/08
A ⁴	Revisions	BSM	LW	010086	02/12/08
A ⁵	Revisions	BSM	LW	010086	02/18/08
A ⁶	Revisions	BSM	LW	010086	02/27/08
A ⁷	Revisions	MWS	JS	010086	02/28/08
A ⁸	Revisions	BSM	JS	010086	04/29/08
A ⁹	Revisions	BSM	JS	010086	05/07/08
A ¹⁰	Revisions	BSM	JS	010086	05/12/08
A ¹¹	Revisions	BSM	JS	010086	05/12/08
A ¹²	Revisions	BSM	JS	010086	05/12/08
A ¹³	Revisions	BSM	JS	010086	05/12/08
B	Revisions & DCO change	BSM	JS	010727	08/14/08
B ²	Revisions	BSM	JS	010727	08/20/08
B ³	Revisions	BSM	JS	010727	09/03/08
B ⁴	Revisions	BSM	JS	010727	09/08/08
B ⁵	Minor Revisions	BSM	JS	010727	09/10/08
B ⁶	Revisions	BSM	JS	010727	09/24/08
B ⁷	Revisions	BSM	JS	010727	09/25/08
B ⁸	Revisions	BSM	JS	010727	10/29/08
B ⁹	% changes - minimum and average reduction	MWS	JS	010727	11/17/08
B ¹⁰	Added MA plumbing statement to pg. 7	MWS	JS/AL	010727	01/06/09
B ¹¹	New NSF mark	BSM	JS/AL	010727	02/16/09
B ¹²	Minor revisions	BSM	JS/AL	010727	02/23/09
B ¹³	Minor revisions	BSM	JS/AL	010727	02/24/09
B ¹⁴	Updated Sed1, 2, 3 on Parts List Page 13	MWS	TF/AL	010727	03/19/09